



MV401G Quick Setup Guide

Learn how to set up your new Micodeus Tracker

Copyright ©2020 MICODEUS | All Rights Reserved

1. Product & Accessories

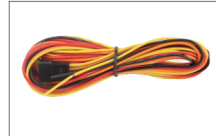

Power Cable (standard)

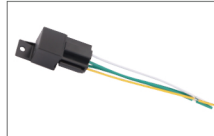

Relay (standard)



SOS Button (standard)



External Battery (option & custom hardware)



iButton (option & custom hardware)



iButton that for ID confirmation will only let a specific driver take off with a chosen vehicle. The engine will not start if the driver hasn't authorized himself. iButton and external battery are customizable hardware (not standard accessories), welcome your inquiry if you need.

2. Specification

Frequency	LTE : FDD(B1/B2/B3/B4/B5/B7/B8/B28);TDD(B40) WCDMA: B1/B2/B5/B8 GSM: B2/B3/B5/B8
Working Voltage	12 / 24 / 36 / 48 / 60 / 72 VDC
Working Current	GPRS(500mA); WCDMA(700mA); LTE(800mA)
Standby Current	Power off(20uA); SLEEP(3mA); IDLE(22mA)
GPRS	Class 12, TCP/IP
Location Accuracy	GPS: 5-15 meters; LBS: >100 meters
TTFF (Open Sky)	Avg. hot starts <3sec Avg. cold starts <35sec
Built-in Battery	140mAh
Working Voltage/Current	9-72VDC/8mA(36V DC)
Operating Temperature	-20°C ~ +70°C
Dimension(mm)	89(L) X 37(W) X 12(H)
Weight	46g

3. SIM Card Installation & Power on

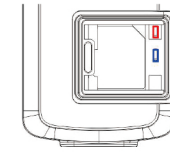
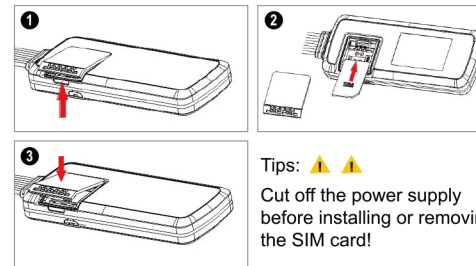

Red / GSM / WCDMA / LTE
Blue / GPS

3.1 GSM/WCDMA/LTE Indicator (Red)

Quick flashing	GSM initializing
Slow flashing	Receive GSM signal normally
No light	No signal / SIM card loose contact / SIM no credit

3.2 GPS Indicator (Blue)

Quick flashing	Searching GPS signal
Slow flashing	Positioned
No light	Power supply failure / Sleep mode

4. Activate Device

Inset the *Mini* Spionlink SIM, which comes with the package. No need to set APN. Included 1MB free data for quick activated. No contracts or other fees.

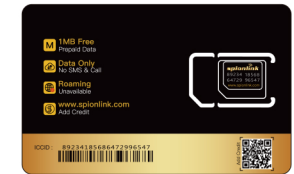

Nano SIM

Micro SIM

Mini SIM

If there's no SIM card in the package, please additionally buy a **4G LTE / 3G WCDMA / 2G GSM SIM card** with enough credit add.

5. Wiring

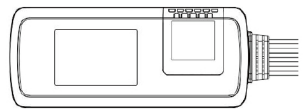

Front view(this side face up to the sky)

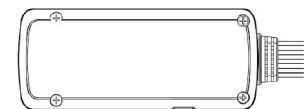

Back view

Tips: ⚠️ ⚠️

MV401G has built-in GSM/LTE and GPS antenna, so it must **face up to the sky** to boost a better signal. Metal thermal barrier & windshield would weaken the signal !

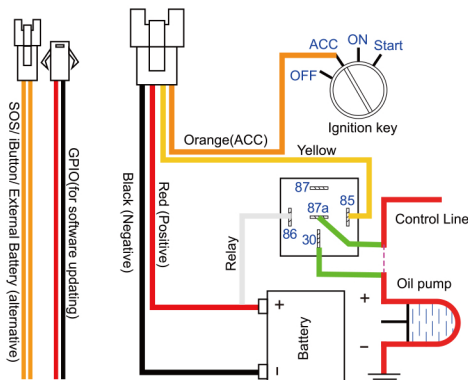

6. Install An App

Search "**MICODEUS**" on APP Store or Google Play, or just scan the QR Code.



Download on the APP Store

Download for Android

7. Sign in

7.1 If this is your first Micodeus Device, tap **IMEI/ID** to input or scan the IMEI or ID number on your device.

The default password is **123456**.

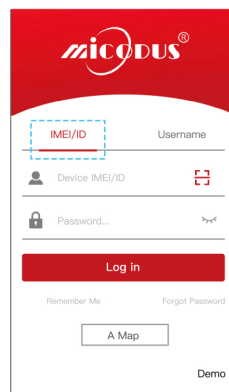

7.2 If you would like to add devices on one account, tap **Username** then tap **Sign Up**.

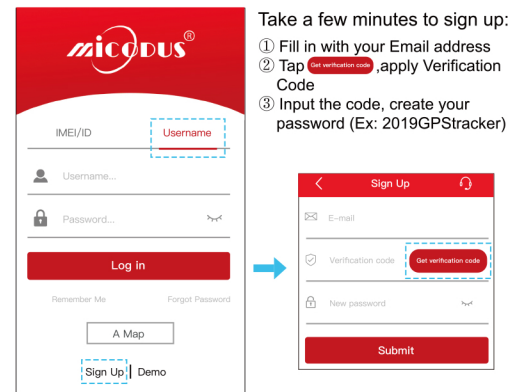

7.3 Tracking platform on Website:
www.micodeus.net

8. Start Using Your Micodeus Tracker

If you would like to learn more about the features, please open the APP to see the **User Guide**.

9. Any Questions?

E-mail: support@micodeus.com

Skype: MICODEUS